

RAINSCREEN PORCELAIN PANEL SYSTEM

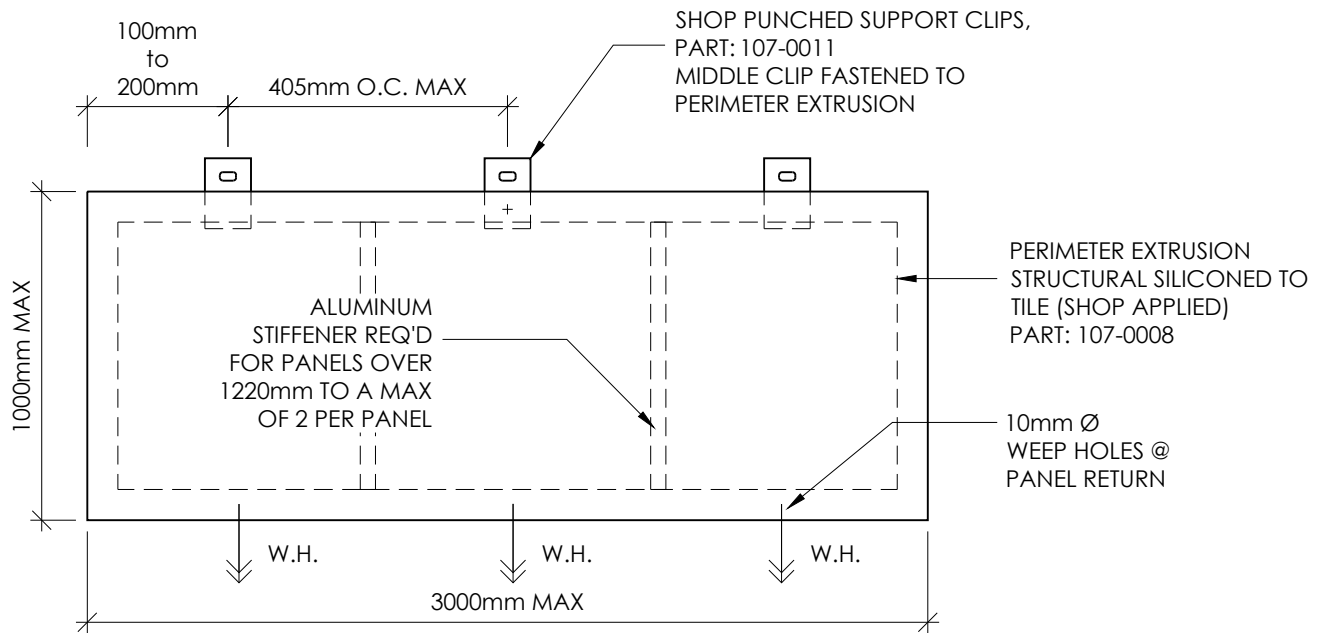

DETAIL LAYOUT



HORIZONTAL FASTENING

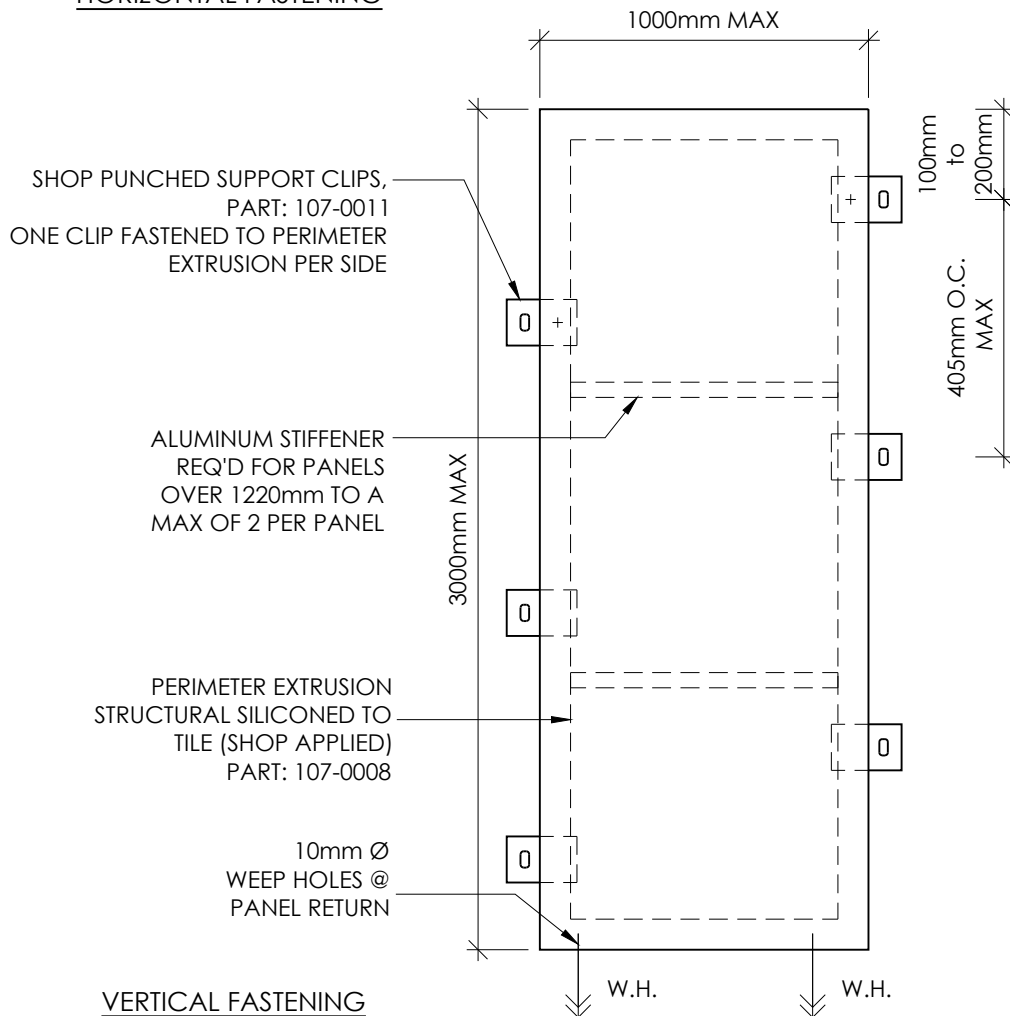

VERTICAL FASTENING



RAINSCREEN PORCELAIN PANEL SYSTEM



PANEL CONFIGURATION

DETAIL 0

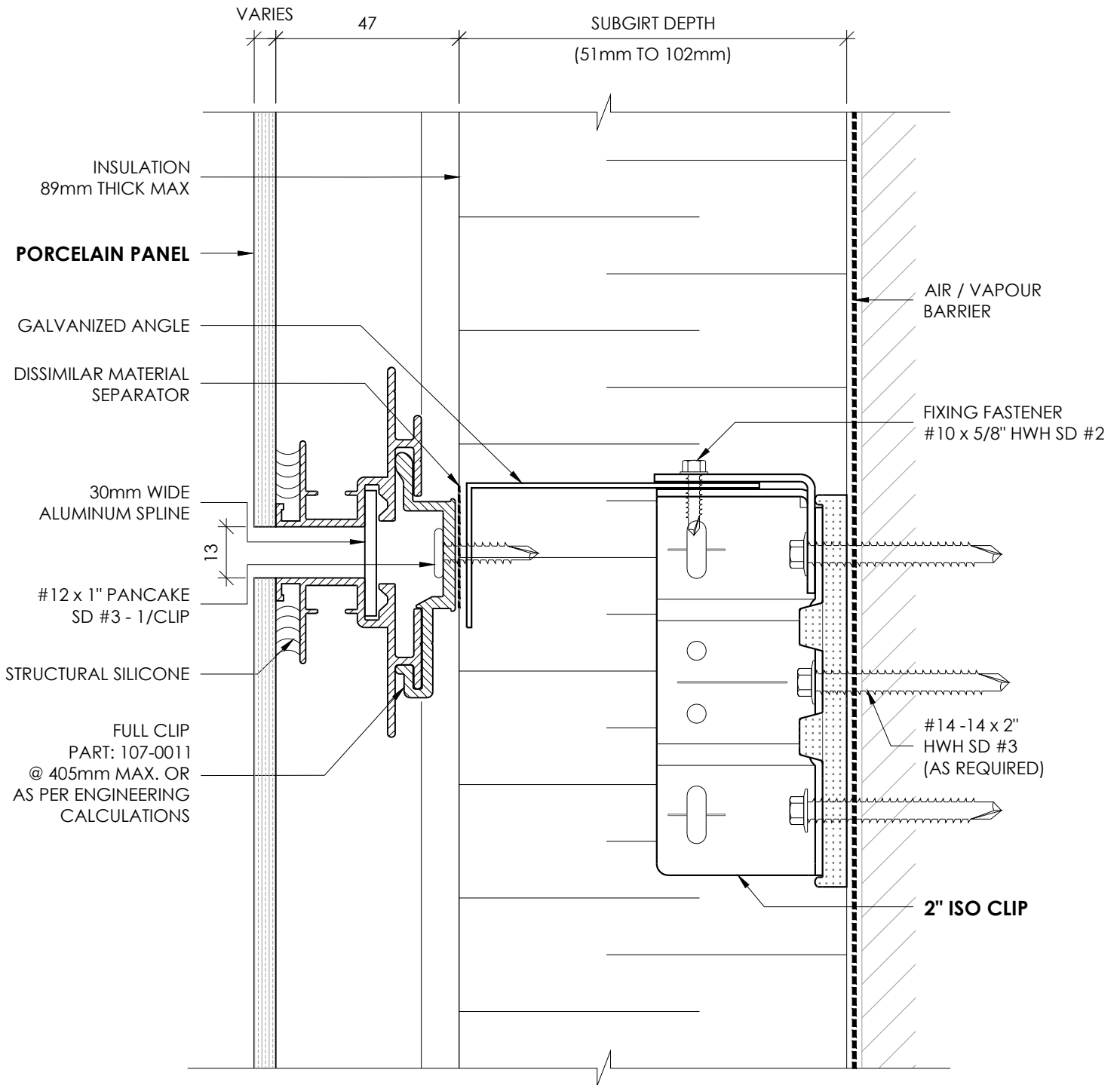

RAINSCREEN PORCELAIN PANEL SYSTEM



HORIZONTAL JOINT
W/ HORIZONTAL SUB-FRAMING

DETAIL 01H

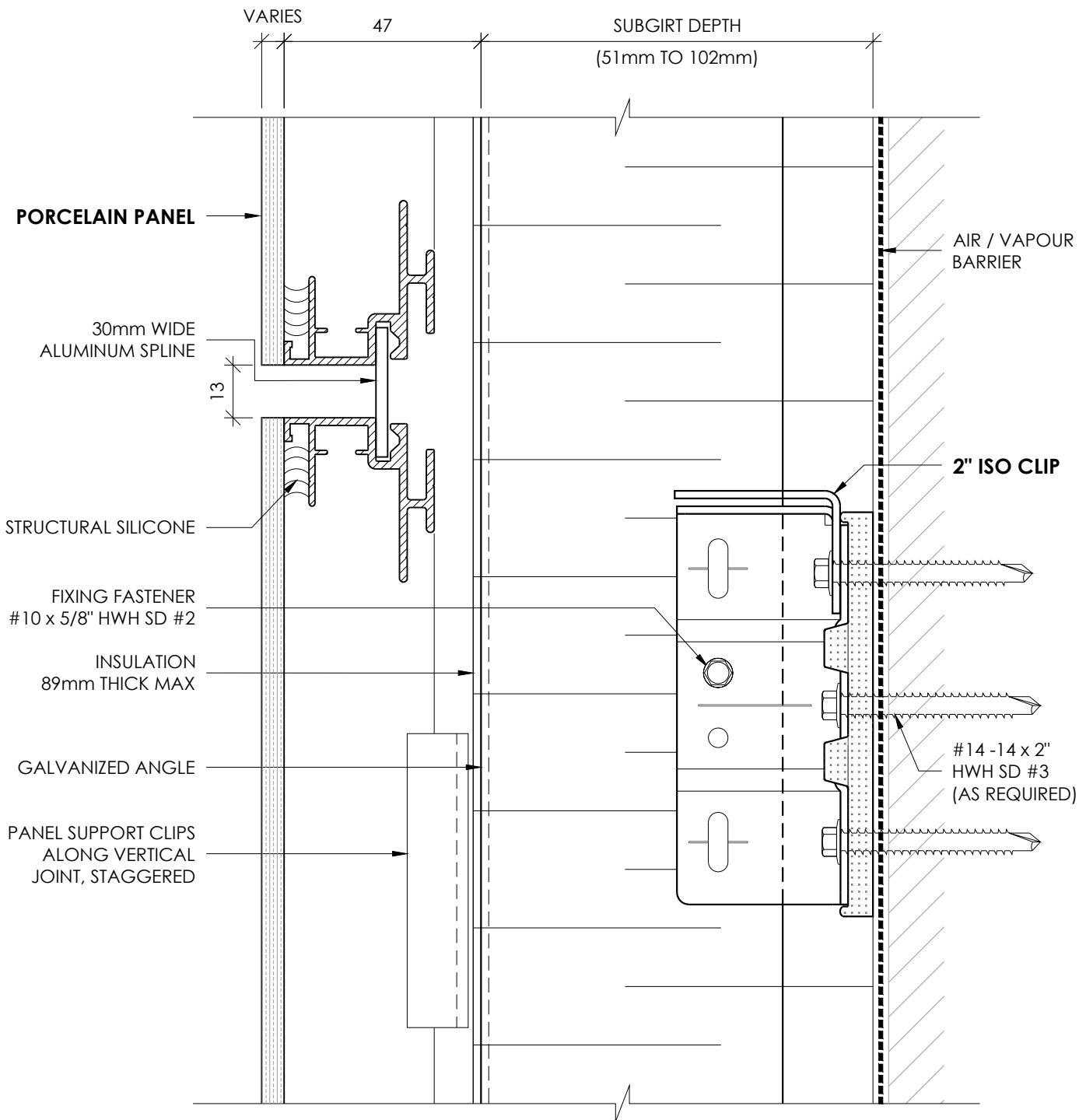

RAINSCREEN PORCELAIN PANEL SYSTEM



HORIZONTAL JOINT
W/ VERTICAL SUB-FRAMING

DETAIL 01V

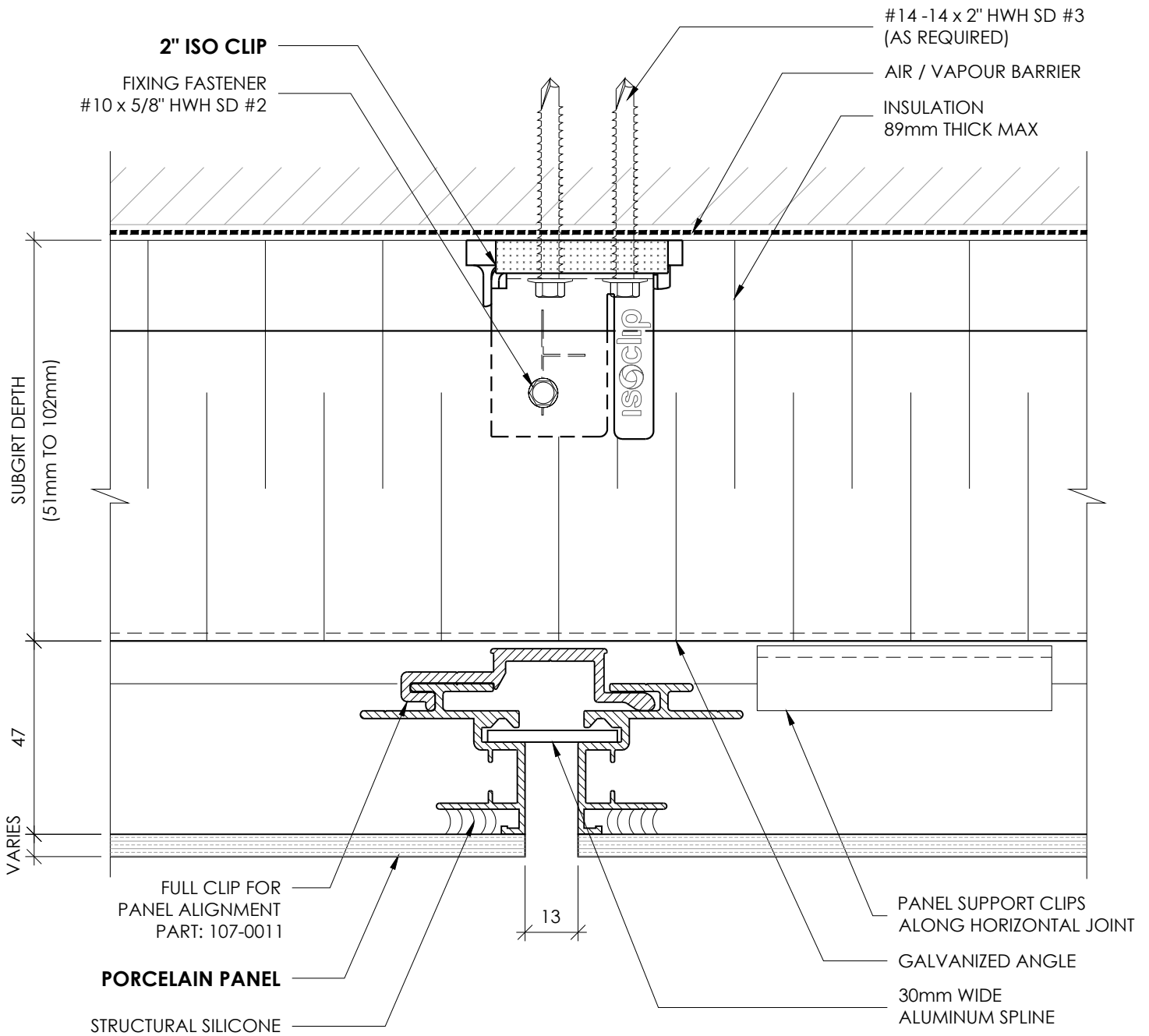

RAINSCREEN PORCELAIN PANEL SYSTEM



VERTICAL JOINT
W/ HORIZONTAL SUB-FRAMING

DETAIL 02H

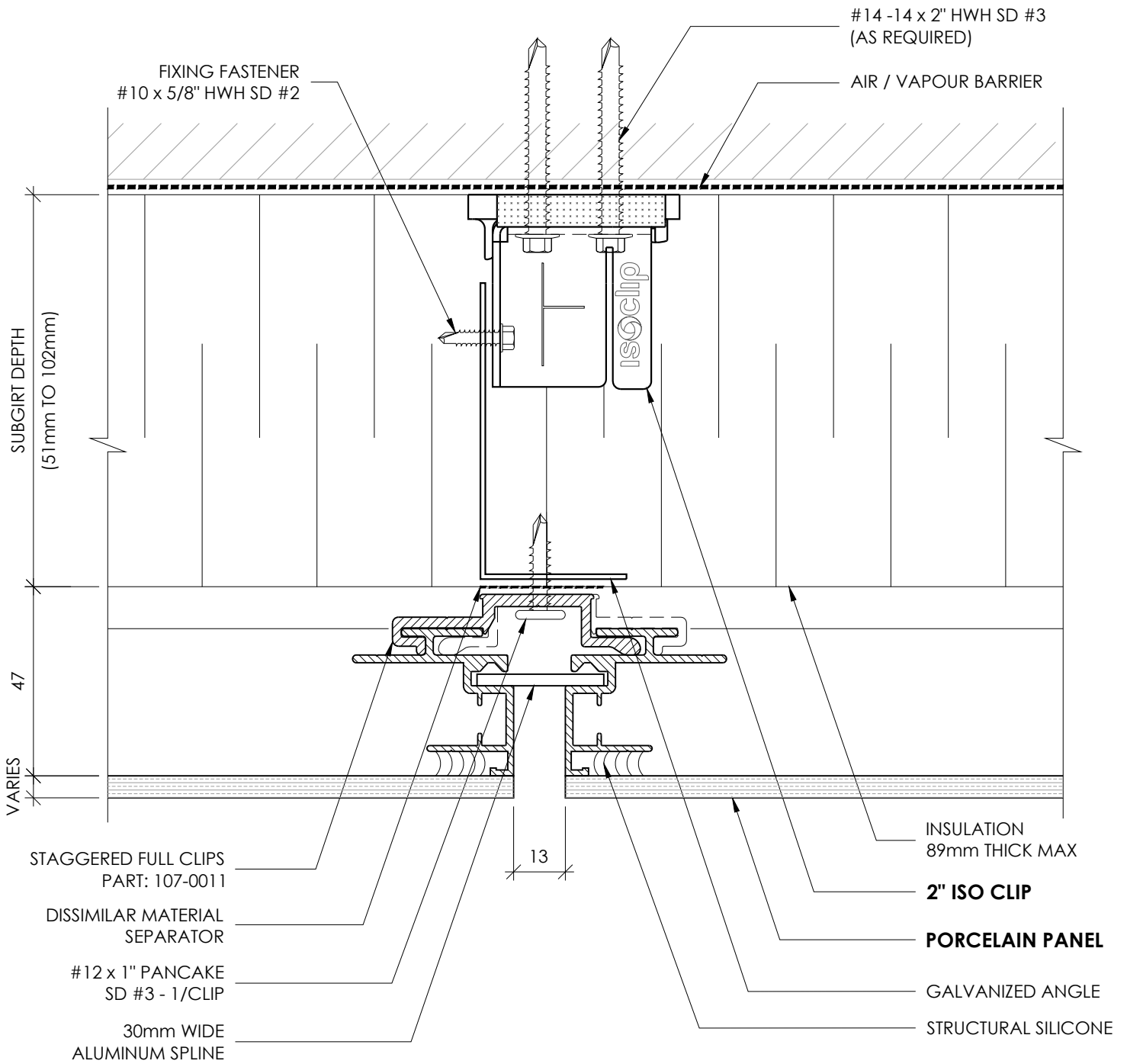

RAINSCREEN PORCELAIN PANEL SYSTEM



VERTICAL JOINT
W/ VERTICAL SUB-FRAMING

DETAIL 02V

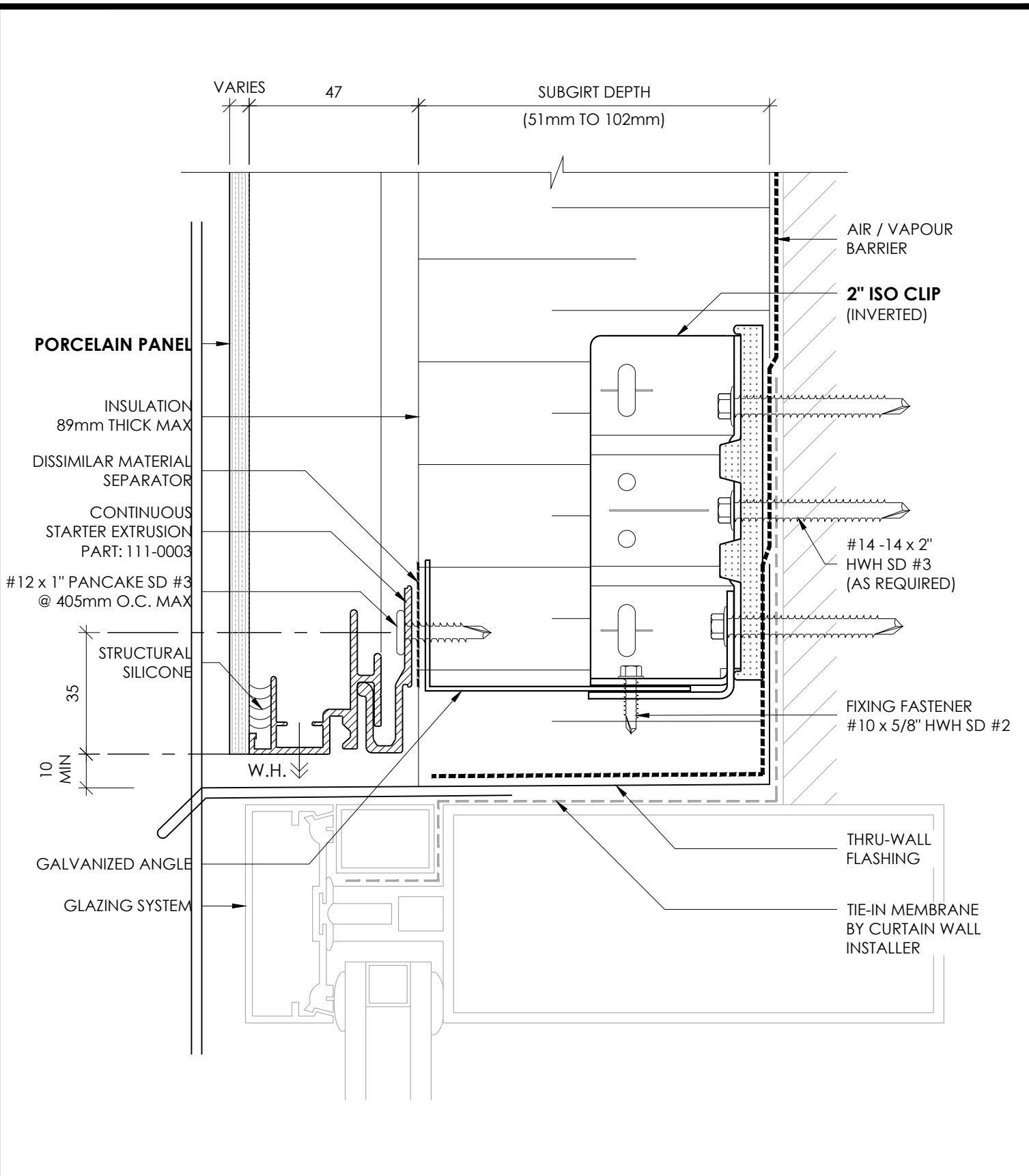

RAINSCREEN PORCELAIN PANEL SYSTEM



**WINDOW HEAD
W/ HORIZONTAL SUB-FRAMING**

DETAIL 03H

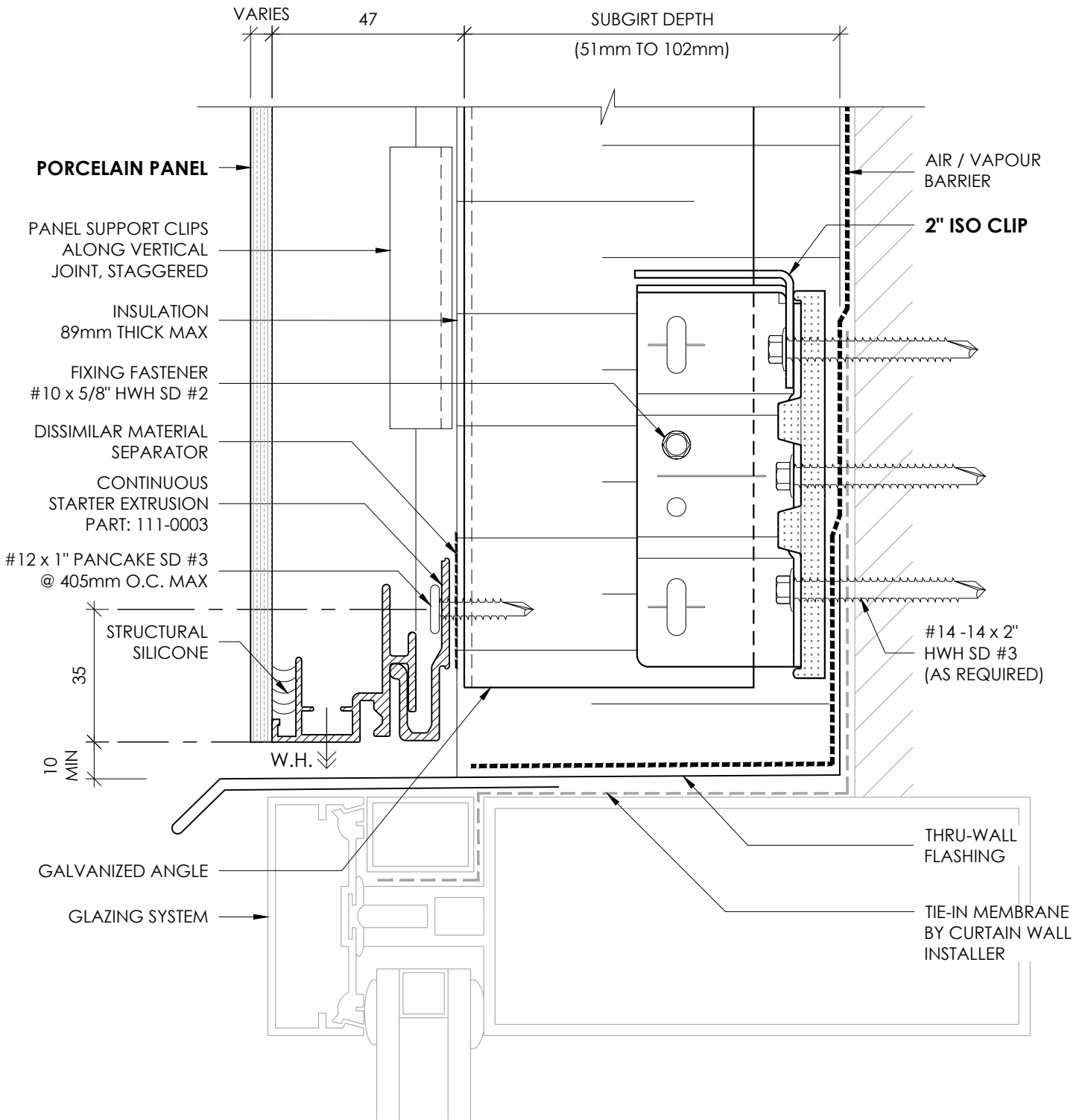

RAINSCREEN PORCELAIN PANEL SYSTEM

STX
RAINSCREEN PORCELAIN

WINDOW HEAD
W/ VERTICAL SUB-FRAMING

DETAIL 03V

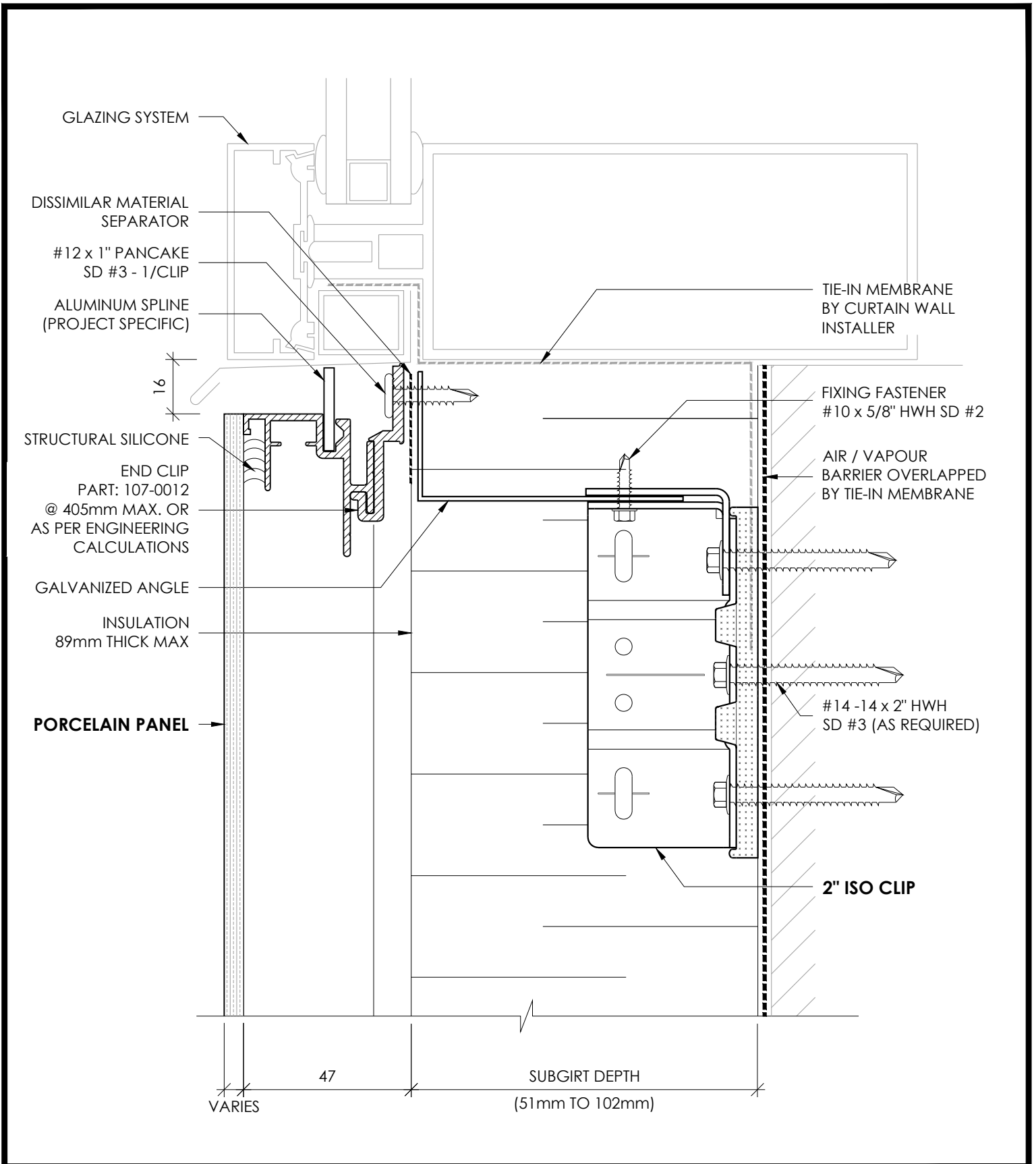

RAINSCREEN PORCELAIN PANEL SYSTEM



**WINDOW SILL
W/ HORIZONTAL SUB-FRAMING**

DETAIL 04H

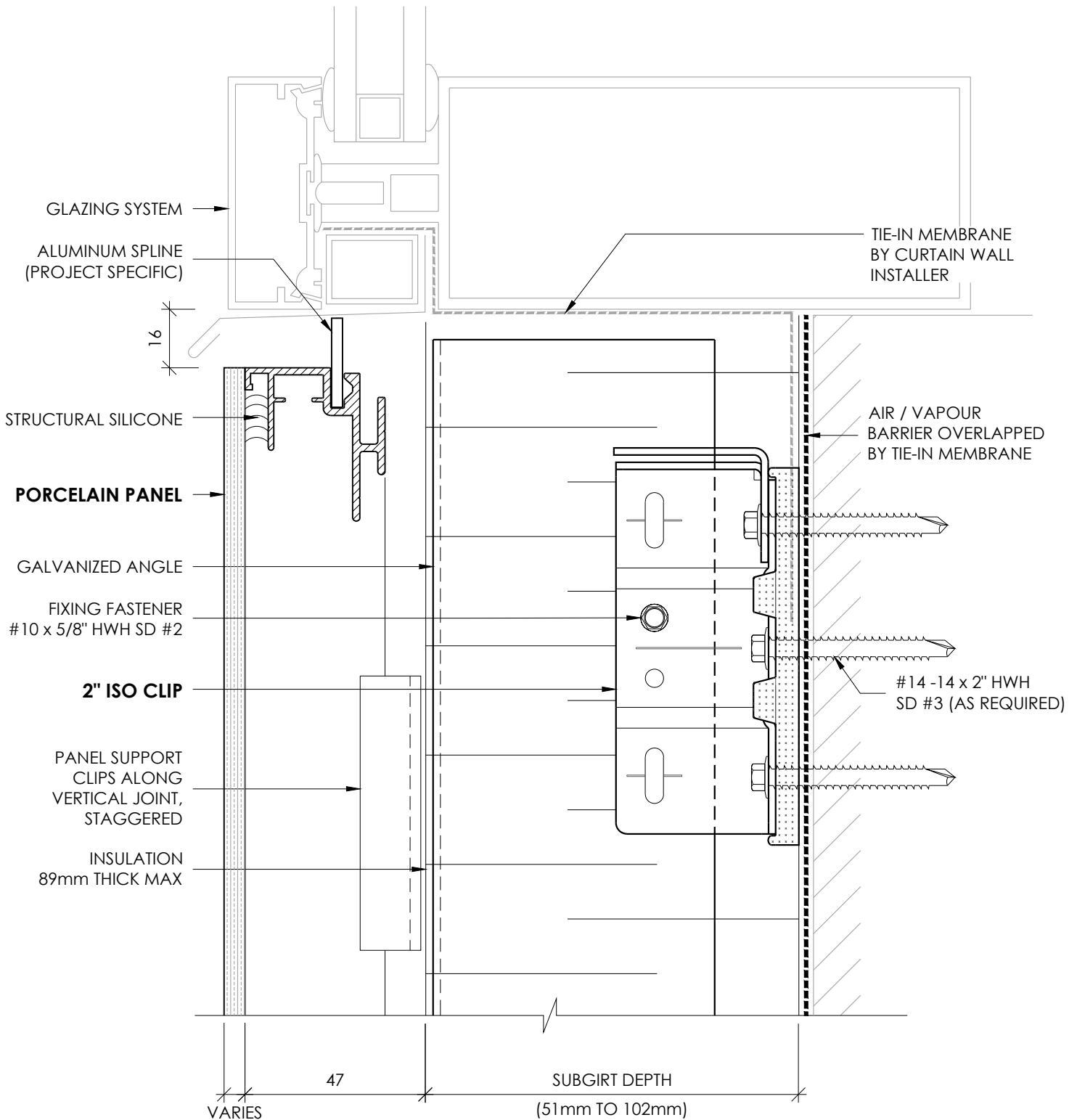

RAINSCREEN PORCELAIN PANEL SYSTEM

STX
RAINSCREEN PORCELAIN

WINDOW SILL
W/ VERTICAL SUB-FRAMING

DETAIL 04V

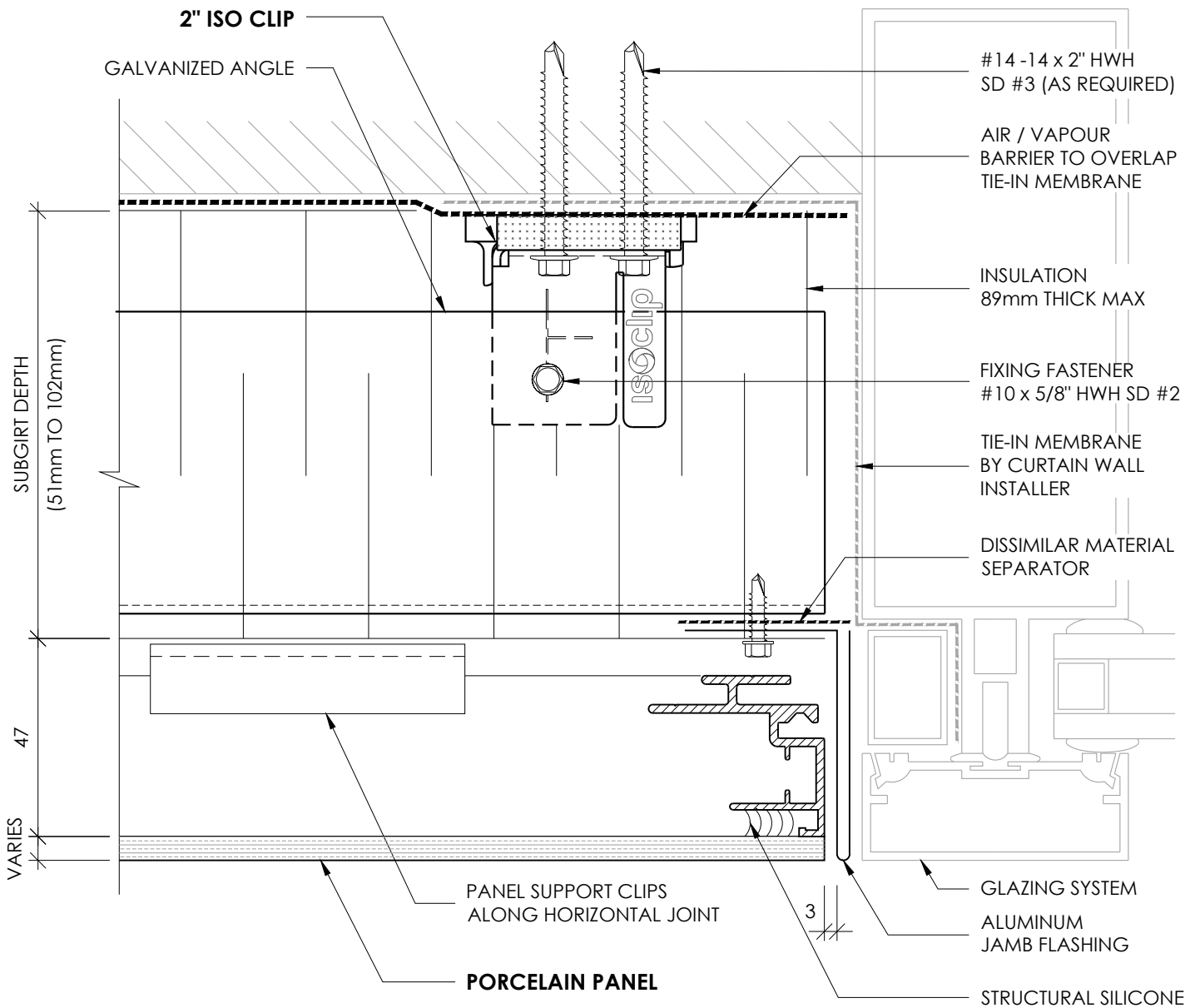

RAINSCREEN PORCELAIN PANEL SYSTEM



**WINDOW JAMB
W/ HORIZONTAL SUB-FRAMING**

DETAIL 05H

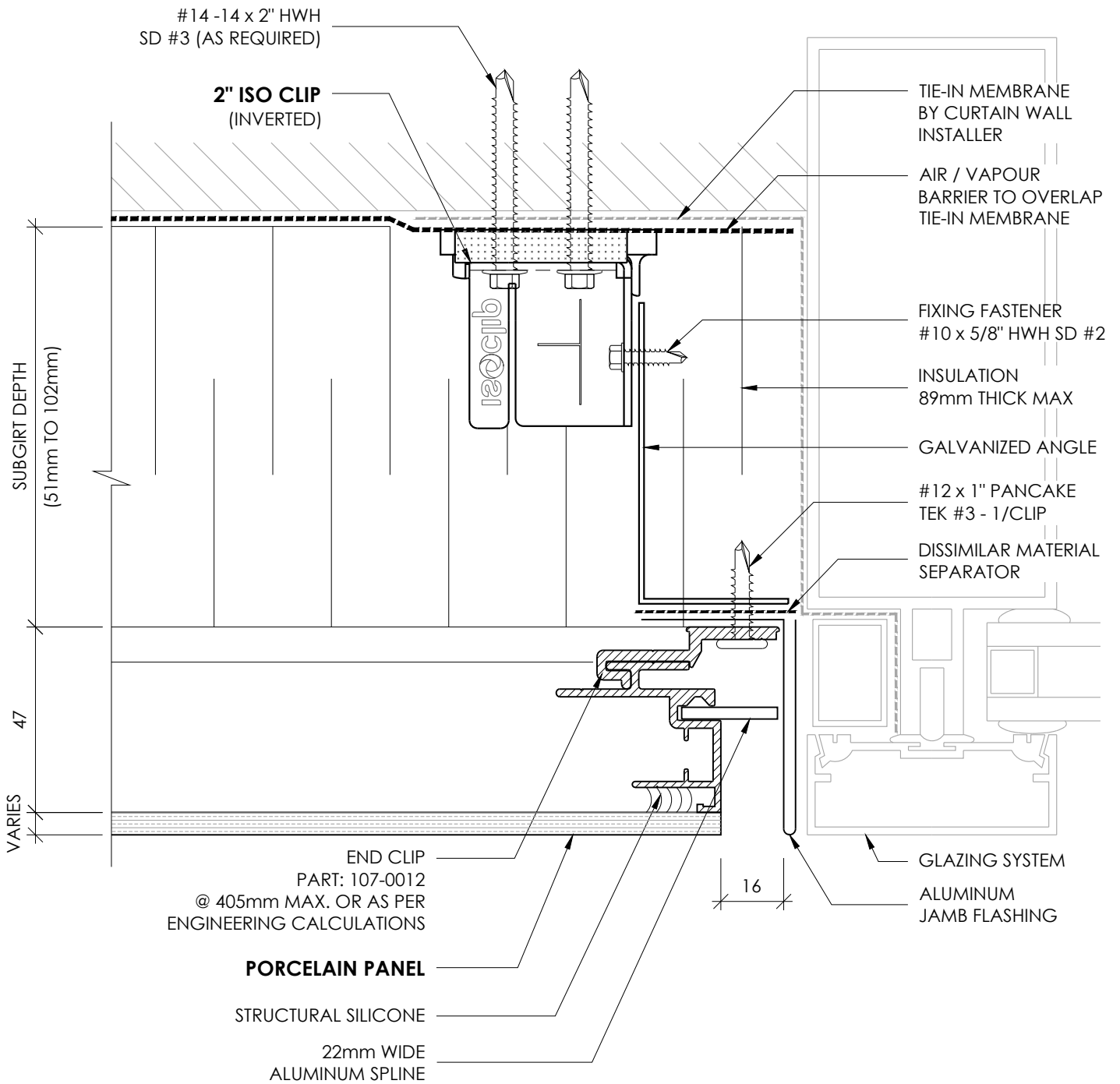

RAINSCREEN PORCELAIN PANEL SYSTEM



**WINDOW JAMB
W/ VERTICAL SUB-FRAMING**

DETAIL 05V

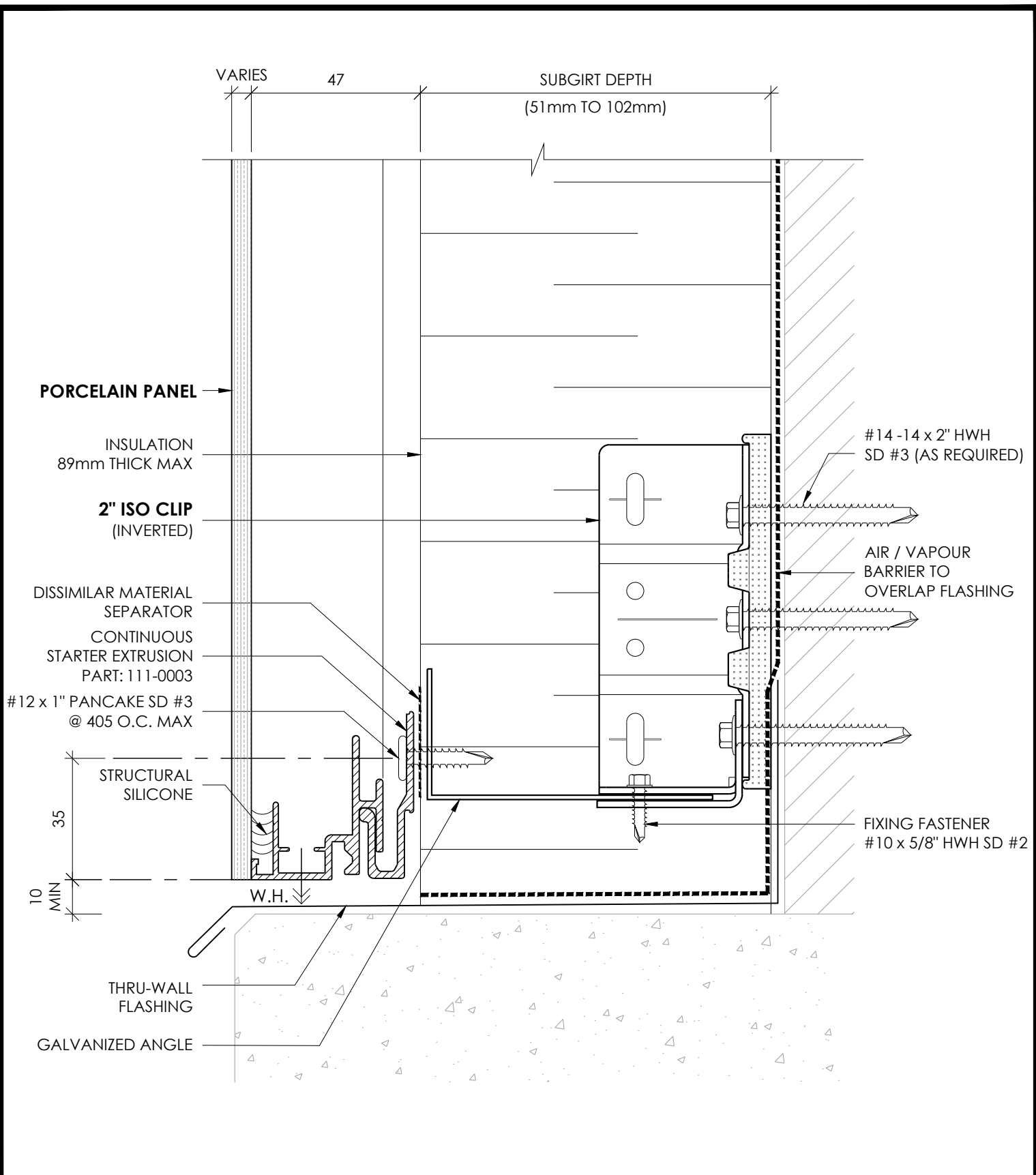

RAINSCREEN PORCELAIN PANEL SYSTEM



**BASE DETAIL
W/ HORIZONTAL SUB-FRAMING**

DETAIL 06H

This drawing is the sole property of and may only be reproduced upon receipt of written permission from FLYNN CANADA LTD. / AUG 2019

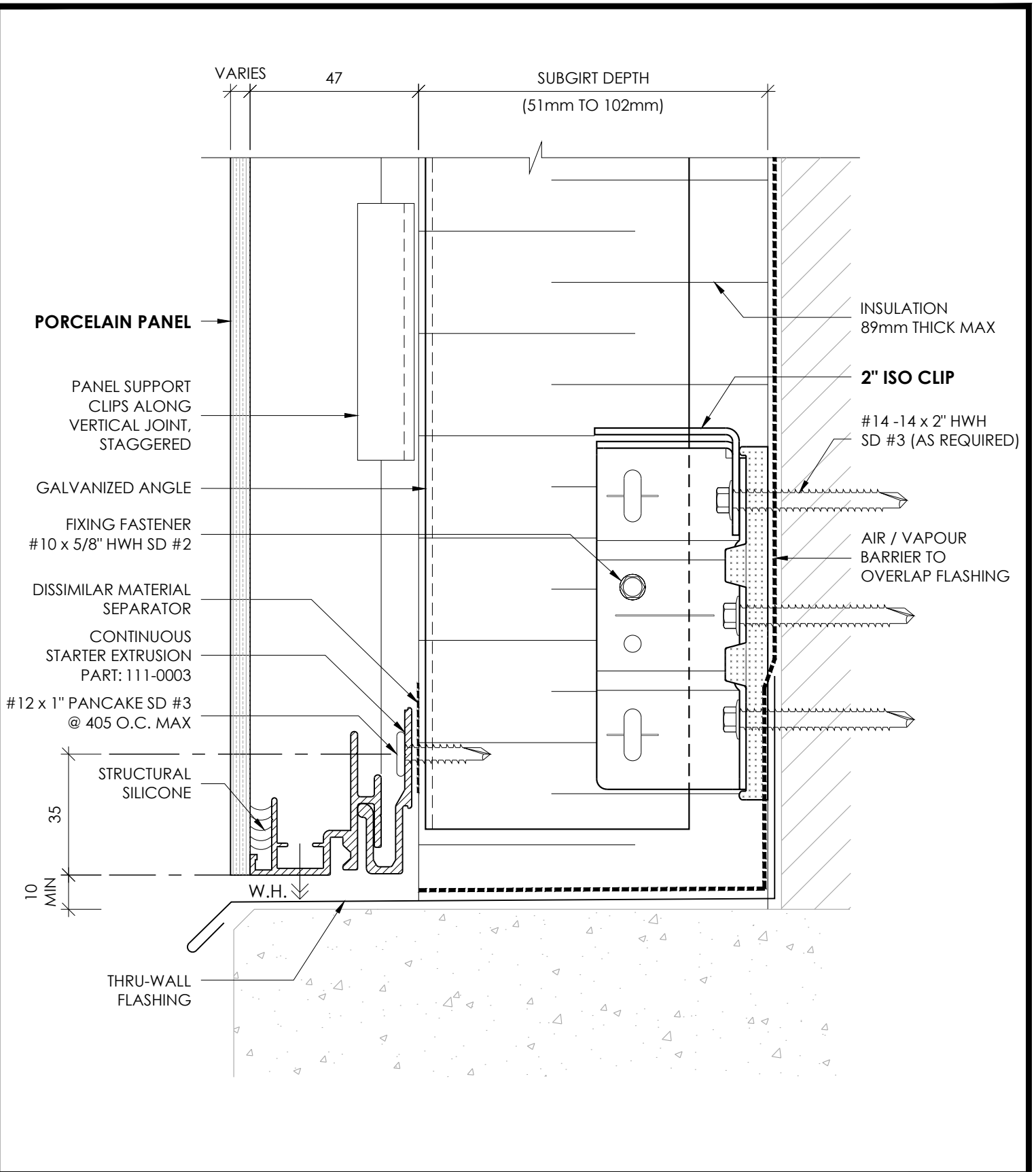

RAINSCREEN PORCELAIN PANEL SYSTEM



**BASE DETAIL
W/ VERTICAL SUB-FRAMING**

DETAIL 06V

**3mm THICK ALUM.
PLATE COPING**

SPLICE PLATE
@ JOINT

END CLIP
PART: 311-0001
(SHIM REQUIRED)

#12 x 1" PAN HEAD
SD #3 - 1/CLIP

35mm WIDE
ALUMINUM SPLINE

STRUCTURAL
SILICONE

END CLIPS
PART: 107-0012
@ 405mm MAX. OR
AS PER ENGINEERING
CALCULATIONS

DISSIMILAR MATERIAL
SEPARATOR

GALVANIZED ANGLE

INSULATION
89mm THICK MAX

2" ISO CLIP

PORCELAIN PANEL

SLOPE

ROOF MEMBRANE
FASTENER
(PROJECT SPECIFIC)
GALVANIZED ANGLE

#14 -14 x 1" HWH SD #3 C/W
NEO-BONDED WASHER

AIR / VAPOUR BARRIER
OVERLAPPED BY ROOF
MEMBRANE

FIXING FASTENER
#10 x 5/8" HWH SD #2

#14 -14 x 2"
HWH SD #3
(AS REQUIRED)

VARIES

47

SUBGIRT DEPTH
(51mm TO 102mm)



RAINSCREEN PORCELAIN PANEL SYSTEM



**PARAPET DETAIL
W/ HORIZONTAL SUB-FRAMING**

DETAIL 07H

**3mm THICK ALUM.
PLATE COPING**

SPLICE PLATE
@ JOINT

END CLIP
PART: 311-0001
@ 405mm MAX. OR
AS PER ENGINEERING
CALCULATIONS

35mm WIDE
ALUMINUM SPLINE

#12 x 1" PAN HEAD
SD #3 - 1/CLIP

STRUCTURAL
SILICONE

DISSIMILAR MATERIAL
SEPARATOR

GALVANIZED ANGLE

FIXING FASTENER
#10 x 5/8" HWH SD #2

PANEL SUPPORT CLIPS
ALONG VERTICAL
JOINT, STAGGERED

2" ISO CLIP

PORCELAIN PANEL

SLOPE

ROOF MEMBRANE
FASTENER
(PROJECT SPECIFIC)
GALVANIZED ANGLE

#14 -14 x 1" HWH SD #3 C/W
NEO-BONDED WASHER

AIR / VAPOUR BARRIER
OVERLAPPED BY ROOF
MEMBRANE

FIXING FASTENER
#10 x 5/8" HWH SD #2

#14 -14 x 2"
HWH SD #3
(AS REQUIRED)

INSULATION
89mm THICK MAX

VARIES

SUBGIRT DEPTH
(51mm TO 102mm)



RAINSCREEN PORCELAIN PANEL SYSTEM



PARAPET DETAIL W/ VERTICAL SUB-FRAMING

DETAIL 07V

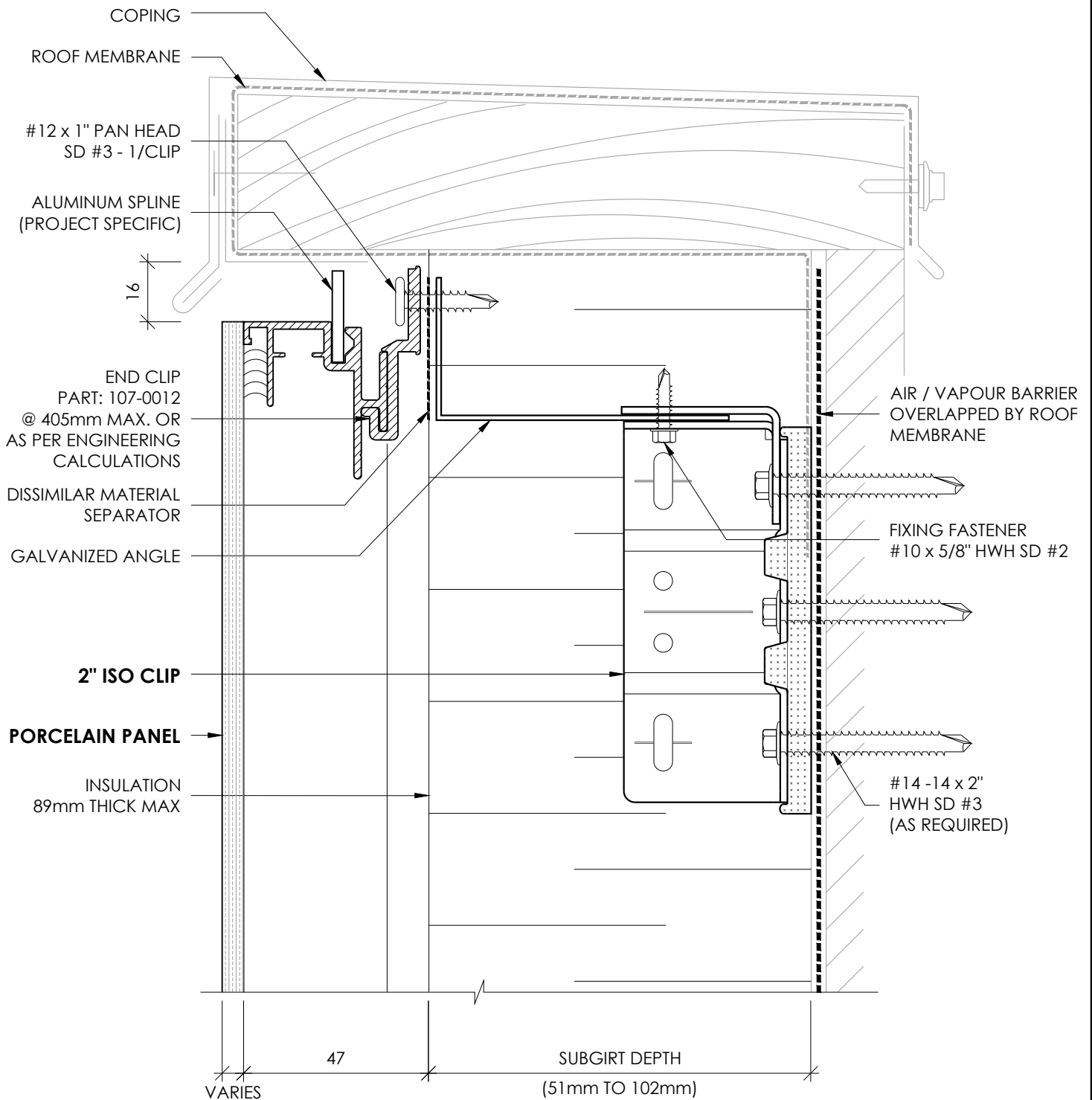

RAINSCREEN PORCELAIN PANEL SYSTEM



PARAPET DETAIL
W/ HORIZONTAL SUB-FRAMING

DETAIL 08H

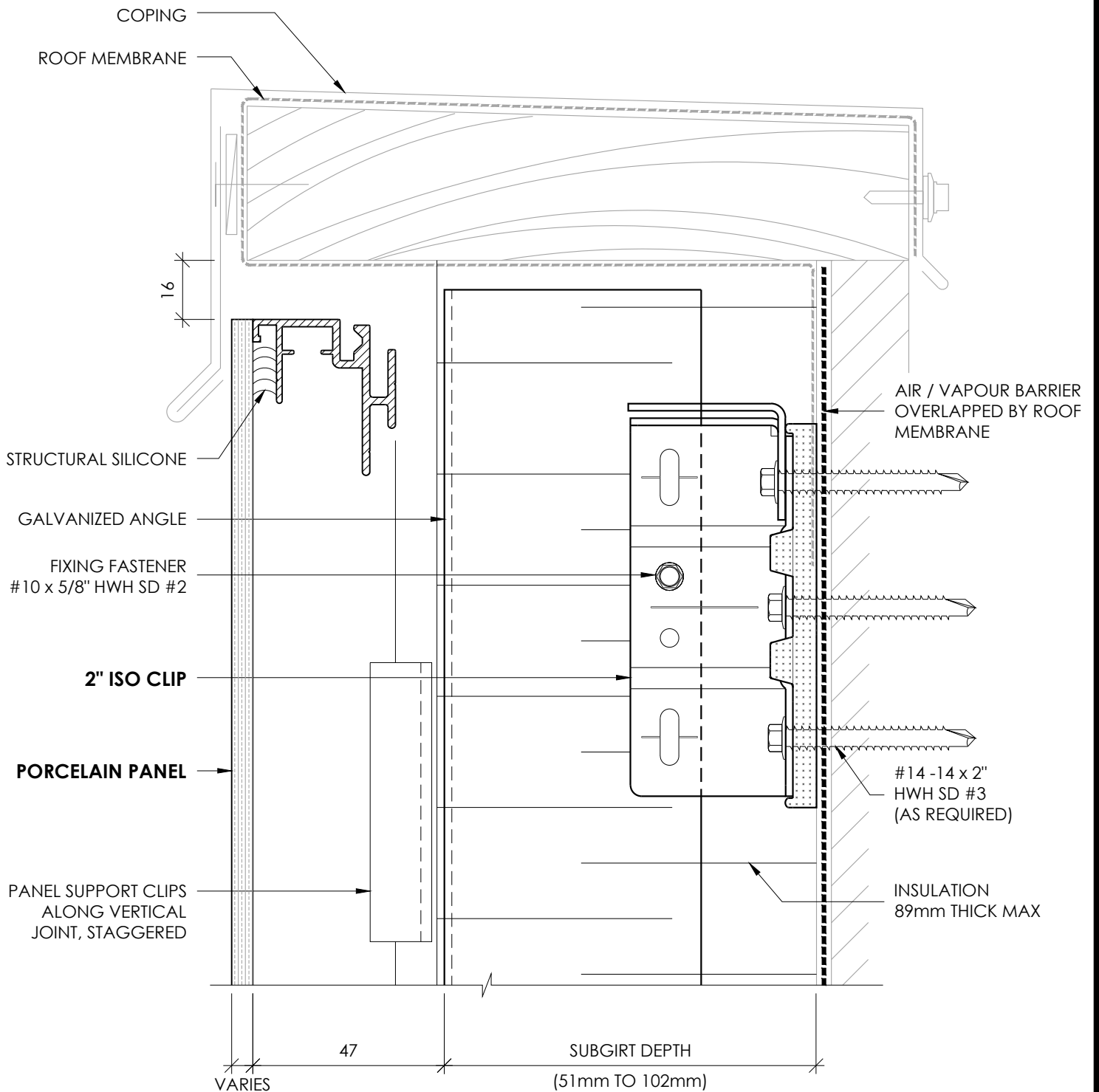

RAINSCREEN PORCELAIN PANEL SYSTEM

STX
RAINSCREEN PORCELAIN

**PARAPET DETAIL
W/ VERTICAL SUB-FRAMING**

DETAIL 08V

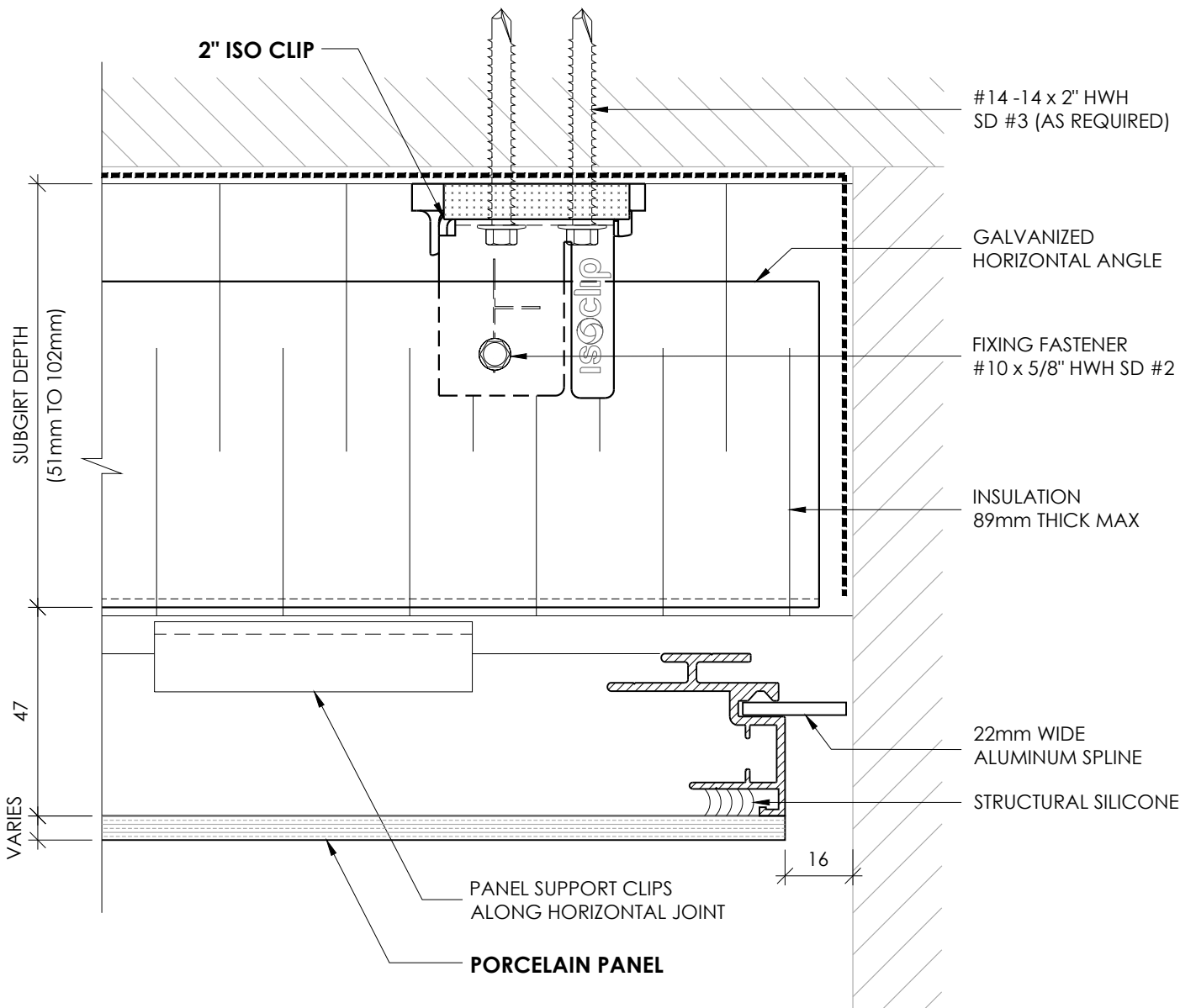

RAINSCREEN PORCELAIN PANEL SYSTEM

STX
RAINSCREEN PORCELAIN

TERMINATION DETAIL
W/ HORIZONTAL SUB-FRAMING

DETAIL 09H

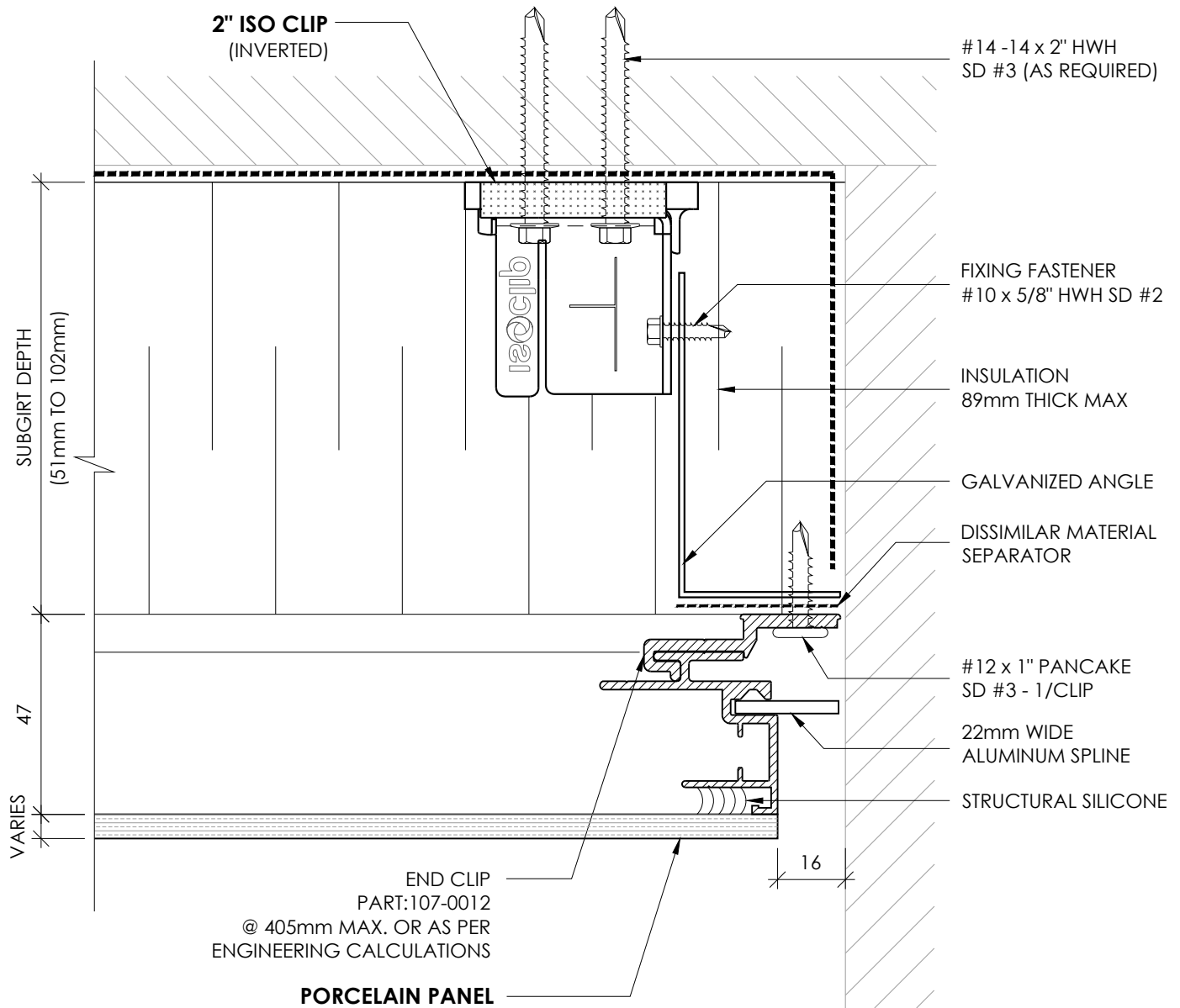

RAINSCREEN PORCELAIN PANEL SYSTEM



**TERMINATION DETAIL
W/ VERTICAL SUB-FRAMING**

DETAIL 09V

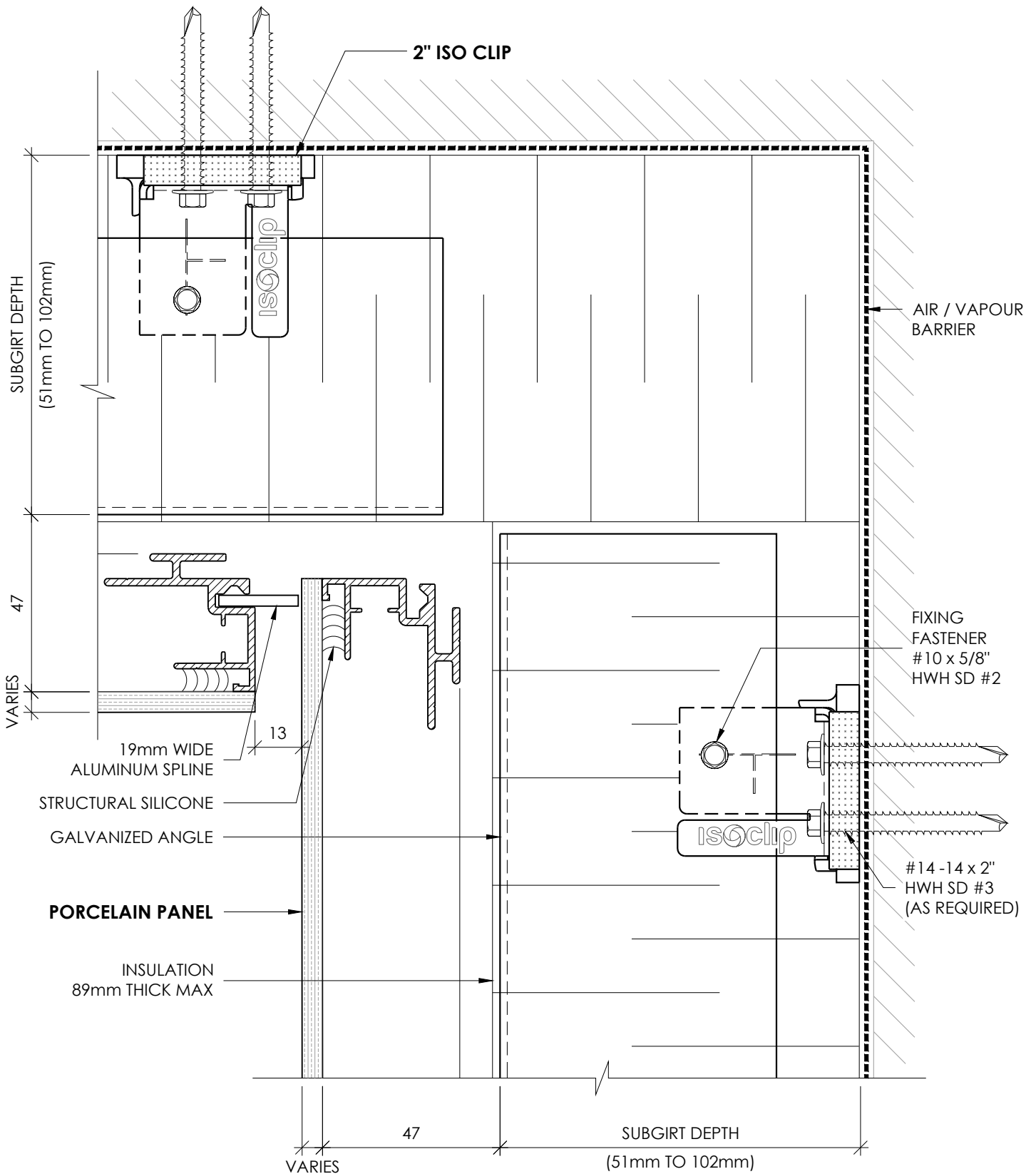

RAINSCREEN PORCELAIN PANEL SYSTEM

STX
RAINSCREEN PORCELAIN

INSIDE CORNER
W/ HORIZONTAL SUB-FRAMING

DETAIL 10H

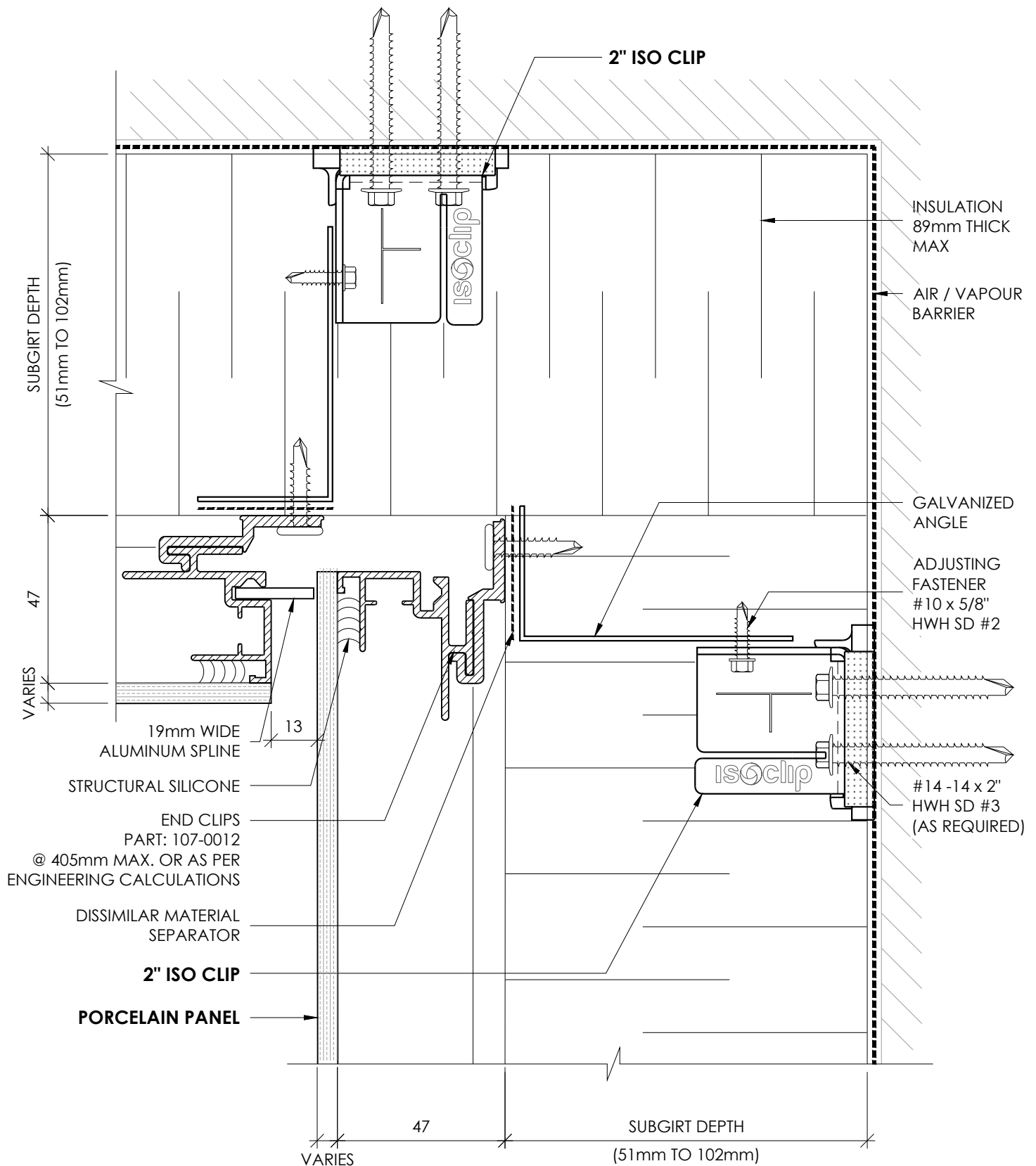

RAINSCREEN PORCELAIN PANEL SYSTEM



**INSIDE CORNER
W/ VERTICAL SUB-FRAMING**

DETAIL 10V

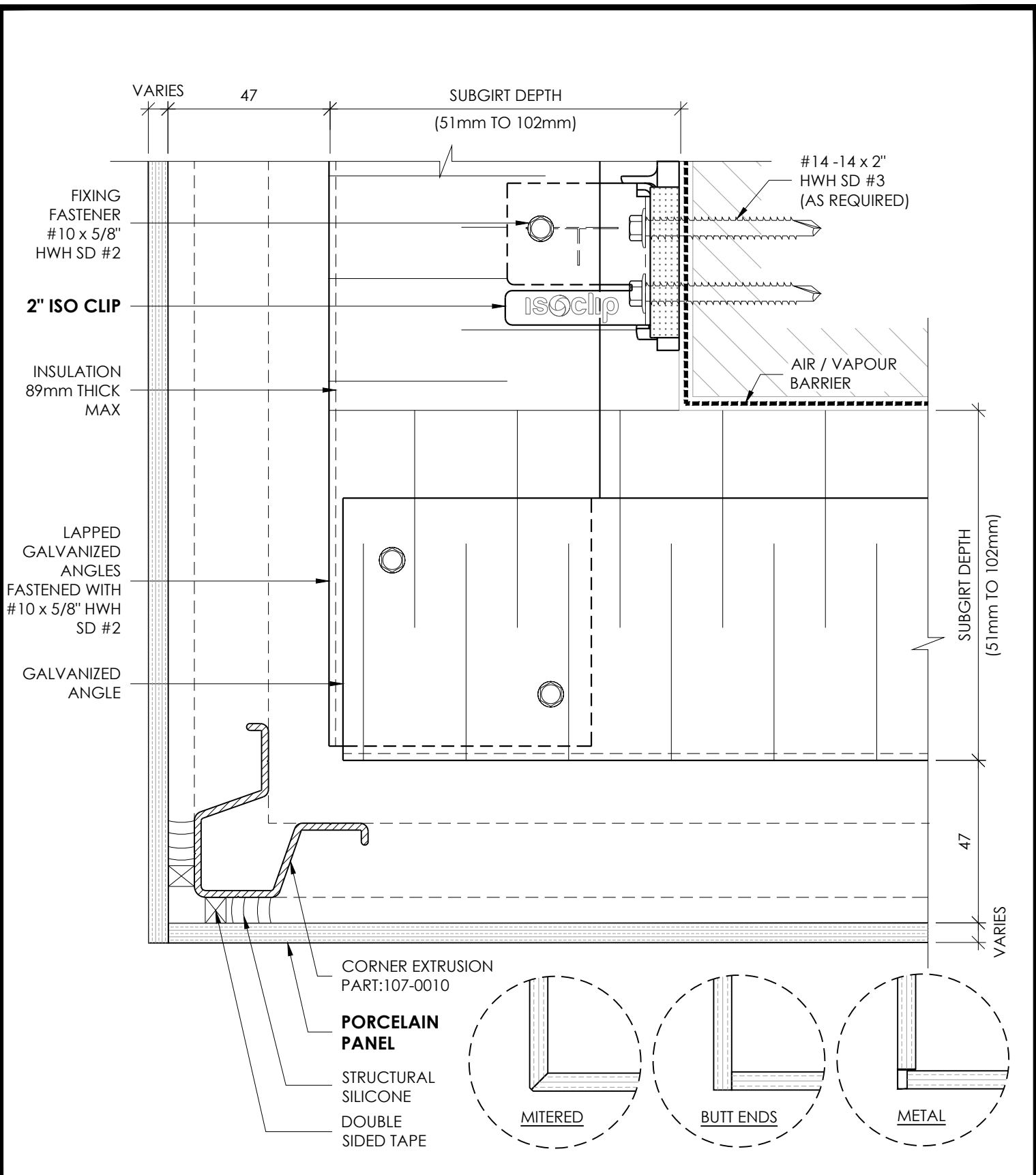

RAINSCREEN PORCELAIN PANEL SYSTEM



OUTSIDE CORNER

DETAIL 11

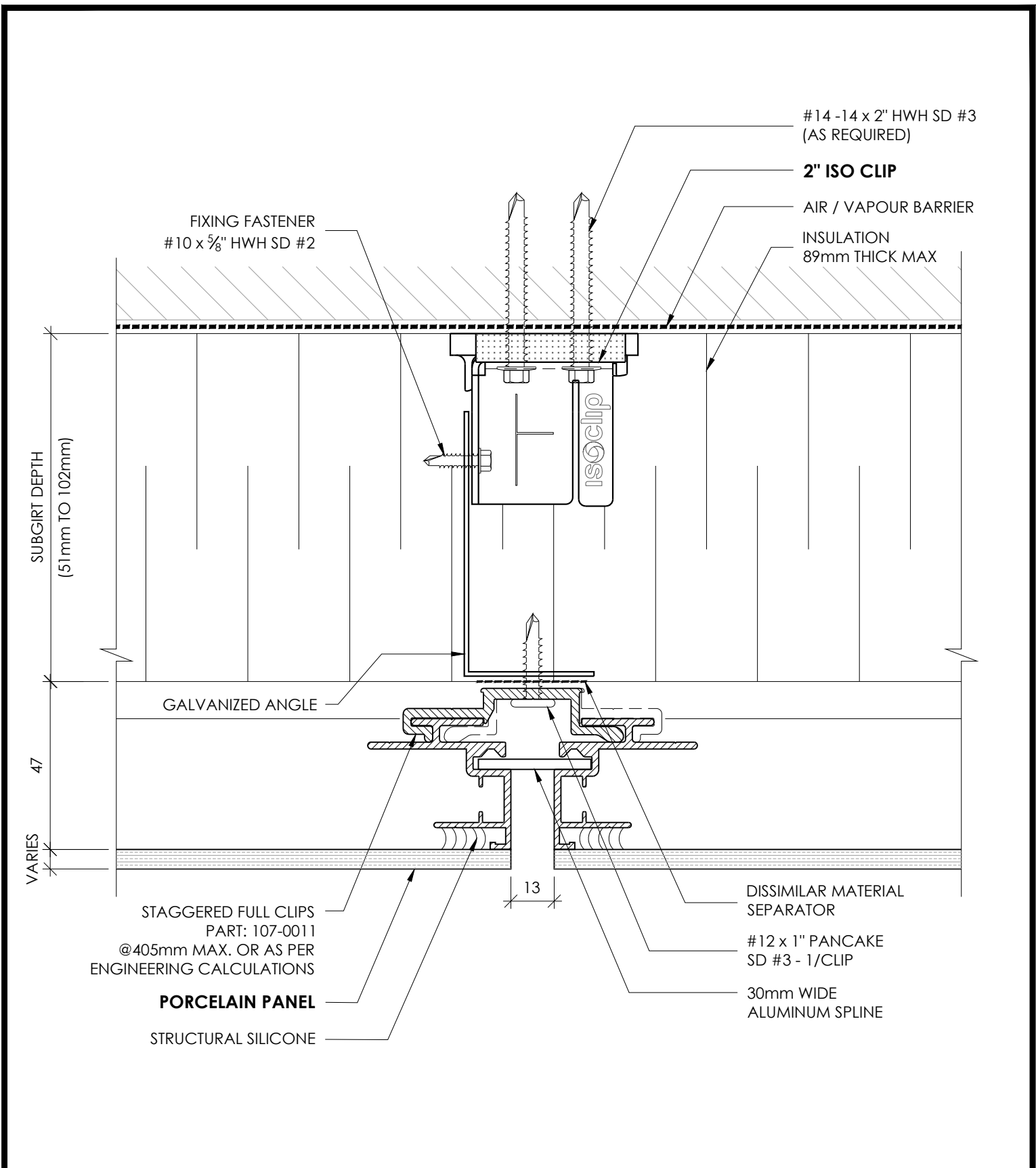

RAINSCREEN PORCELAIN PANEL SYSTEM



SOFFIT JOINT

DETAIL 12

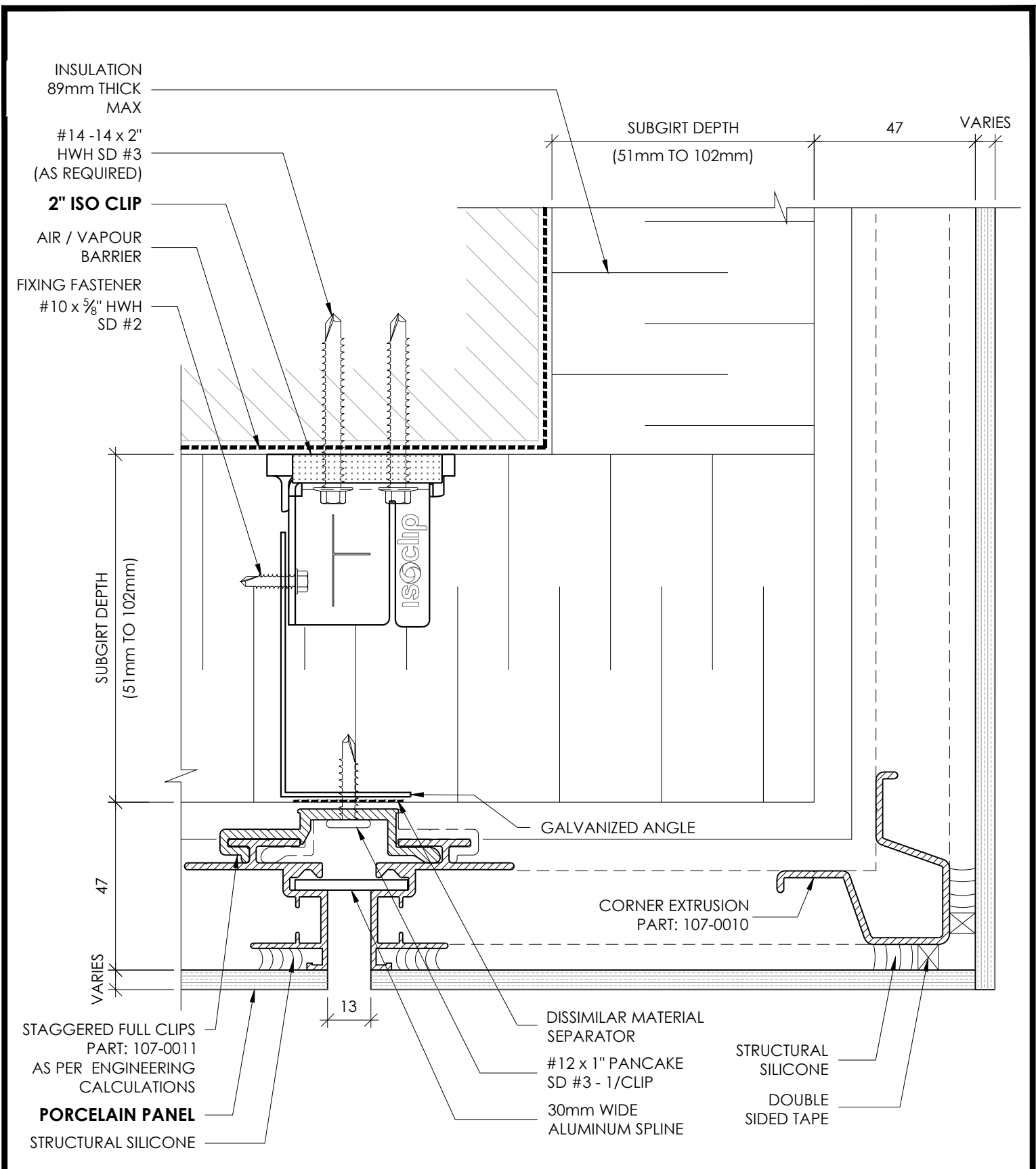

RAINSCREEN PORCELAIN PANEL SYSTEM



SOFFIT FASCIA JOINT

DETAIL 13

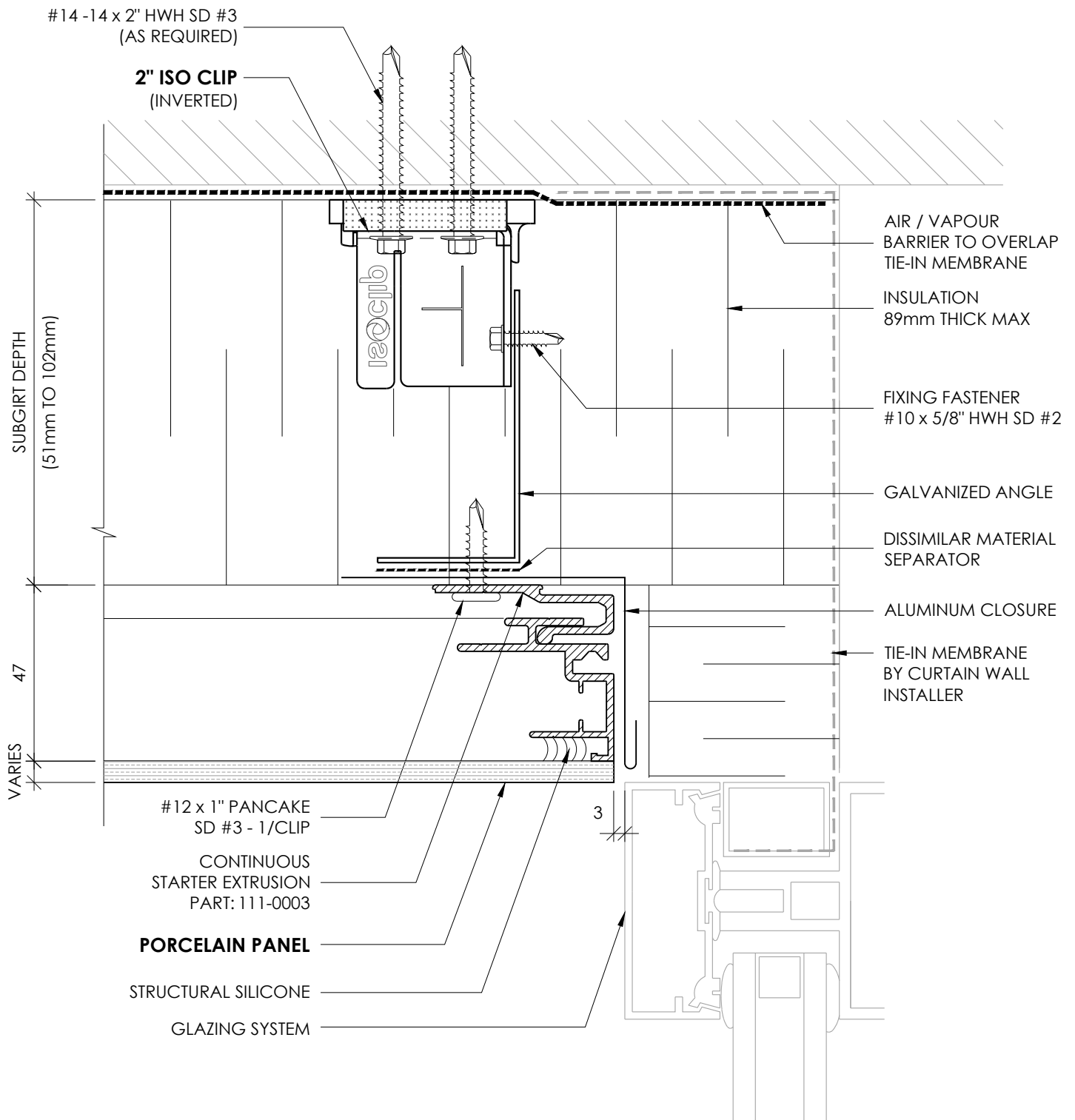

RAINSCREEN PORCELAIN PANEL SYSTEM



SOFFIT TERMINATION JOINT

DETAIL 14